



HIGH PERFORMANCE

EVEREXCEED AGM TECHNOLOGY



FT12V80

VALVE REGULATED

LEAD ACID BATTERY (AVR)

FOR COMMUNICATION

STANDBY POWER APPLICATIONS

12V 81.5AH @ 10 HR RATE to 1.80VPC

12V 80.4AH @ 8 HR RATE to 1.75VPC

12V 244WATTS/CELL @ 15MIN RATE to 1.67VPC

LONG DURATION

Innovative Features

- ☑ Virgin Pure Lead Tin and thick positive plate technology design for maximum service float life - 15 years design life @ 20°C(68°F);
- ☑ UL Recognized component;
- ☑ Valve regulated lead acid battery (VRLA);
- ☑ Optimized high-compression Absorbed Glass Mat (AGM) materials significantly enhance performance and reliability, greater than 99% recombination efficiency;
- ☑ Proprietary Fixed Orifice Plate Pasting technology applying active materials on both sides of the grid for consistent cell-to-cell performance, higher capacity and uniform grid protection.
- ☑ Advanced triple stage unique terminal sealing design to ensure leak free operation;
- ☑ Operates at a low internal pressure;
- ☑ Heavy duty M6 / M8 Female copper plated terminals provide maximum performance and easy installation, reduce maintenance and increase safety;
- ☑ Advanced lead tin low-calcium alloy, reduces grid corrosion and promotes long battery life;
- ☑ Optional: Reinforced ABS (UL 94HB) container and cover; Standard: Flame-retardant reinforced ABS case and cover compliant with U.L.94 V-0 with an Oxygen Limiting Index of greater than 28%; Designed to withstand extreme temperature degrees and performance without degradation;
- ☑ Over-sized, through the partition inter-cell welds provide low resistance connections, with minimal power loss;
- ☑ Flame arresting, low pressure safety release venting system for individual cells, recognized per U.L.924;
- ☑ Multi-cell design for ease of installation and maintenance;
- ☑ Horizontal or vertical operation.

12 VOLTS - 81.5 AMPERE HOUR @ 10 HOUR RATE

AH Capacity to 1.80VPC @ 20°C (68°F)

End Point Volts/Cell	1.5hr	2hr	3hr	4hr	5hr	6hr	8hr	10hr	12hr	20hr	24hr
1.80	58.0	62.1	66.3	69.4	71.9	76.2	78.3	81.5	83.1	90.4	91.7

For Mobility / Solar / Marine Telecommunication Applications

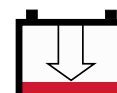
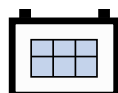

FT AGM Range VRLA

EverExceed[®]
power your applications

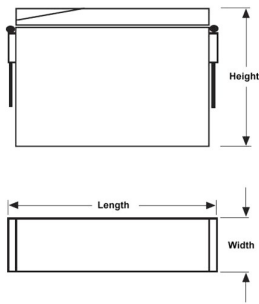
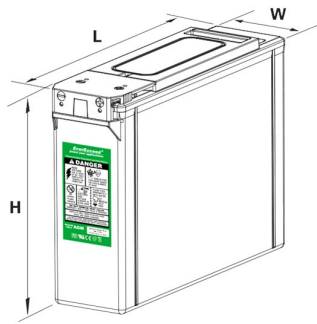

Plastic screwed cap to hold down flat and o-ring

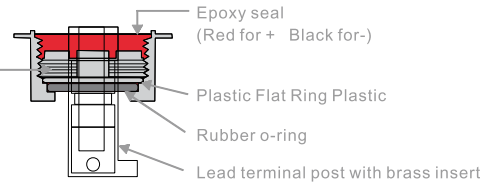

Length (L): 395 mm
Width (W): 110 mm
Height (H): 285 mm

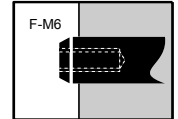
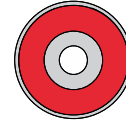

Electrical Specifications

Cells Per Unit	Voltage Per Unit	Weight	Electrolyte	Maximum discharge current	Short Circuit Current	Ohms Imped 60 Hz(Ω)
6	12.84	61.7lbs 28.0kg	SG = 1.300	508 Amps	2450 Amps	0.00512

Capacity	81.5 Ah @ 10 hr. rate to 1.80 volts per cell @ 20°C (68°F). 80.4 Ah @ 8 hr. rate to 1.75 volts per cell @ 20°C (68°F). 244 Watts per all at the 15 minute rate to 1.67 volts per cell @ 20°C (68°F).
Applicable Operating Temperature Range	-40°C (-40°F) to +70°C (+158°F).
Ideal Operating Temperature Range	+20°C (+68°F) to +28°C (+82.4°F).
Floating Charging Voltage	13.5 to 13.8 VDC/unit Average at 25°C (77°F).
Recommended Maximum Charging Current Limit	0.2C20 amperes (18.6 amperes @ 100% depth of discharge) @ 20 hr. rate to 1.75VPC.
Equalization and Cycle Service Charging Voltage	14.1 to 14.4 VDC/unit Average at 25°C (77°F).
Maximum AC Ripple (Charger)	0.5% RMS or 1.5% P-P of float charge voltage recommended for best results. Maximum voltage allowed = 1.4% RMS (4% P-P). Maximum current allowed = 4.65 amperes RMS (C/20) to 1.75VPC.
Self Discharge	EverExceed FT AGM Range batteries may be stored for up to 12 months at 20°C~25°C (68°F~77°F) and then a freshening charge is required. For higher temperatures the time interval will be shorter.
Accessories	Inter unit connectors racks and cabinet systems are available.
Terminal: Inserted	Threaded copper alloy insert terminal
Terminal Hardware Initial Torque: Inserted Terminal	9 NM

Constant Power Discharging Ratings - Watts Per Cell @ 20°C (68°F)

End Point Volts/Cell	1.5hr	2hr	3hr	4hr	5hr	6hr	8hr	10hr	12hr	20hr	24hr
1.85	70.1	56.6	40.6	32.1	28.3	26.7	18.4	15.4	13.1	8.57	7.26
1.80	73.8	59.6	42.8	33.9	29.9	28.2	19.4	16.1	13.8	9.01	7.64
1.75	75.3	61.1	43.7	34.5	30.4	28.7	19.7	16.4	14	9.2	7.79

Constant Current Discharging Ratings - Ampere per Cell @ 20°C (68°F)

End Point Volts/Cell	1.5hr	2hr	3hr	4hr	5hr	6hr	8hr	10hr	12hr	20hr	24hr
1.85	36.4	29.3	20.8	16.4	13.6	12	9.24	7.7	6.55	4.28	3.62
1.80	38.7	31.0	22.1	17.4	14.4	12.7	9.79	8.15	6.92	4.52	3.82
1.75	39.6	31.8	22.7	17.8	14.7	13.0	10.0	8.37	7.11	4.65	3.93

Note: Batteries to be mounted with 0.5 in (1.25 cm) spacing minimum and free air ventilation. Specifications subject to change without notification.

