

# EverExceed Smart IT Cabin Solution User Manual



## Content

Chapter 1	Overview .....	2
1.1	Model Description .....	2
1.2	Features .....	3
1.3	Functional Components .....	3
1.4	Operational Environment .....	5
Chapter 2	Preliminary Before Installation .....	5
2.1	Conveying, Unpacking and Inspection .....	6
2.2	AC Installing .....	8
Chapter 3	Operation instructions .....	10
3.1	Check before Startup .....	10
3.2	Startup .....	11
3.3	Power off .....	11
Chapter 4	Operation on Display Panel .....	12
4.1	The Smart IT Cabin Home page .....	12
4.2	Menu items .....	13
4.3	Remote Control .....	26
Chapter 5	Maintenance .....	31
5.1	Safety Instruction .....	31
5.2	AC System Maintenance .....	31
5.3	UPS Power Distribution System Maintenance .....	33
5.4	Troubleshooting .....	33

## Chapter 1 Overview

Smart IT Cabin integrated solution is a mini datacenter solution produced by Shenzhen EverExceed Industrial Co., Ltd; it is applicable to the indoor environment such as data center or office area. Smart IT Cabin is used to store the 19"rack mount hardware equipment which complies with the industry-standard(EIA-310-D) such as server, data, voice, internet network equipment, it contains power supply and distribution system, air conditioning system, a rack supporting system and monitoring management system. These four systems work closely with each other with seamless compatibility, thus realizing the high-efficiency operation of miniature datacenter and maintaining normal and stable operation of important devices such as servers inside the cabinet. Standard design, standard field installation, no need of raised floor and integrated delivery shorten the delivery period to great extent. The monitoring management of all range of EverExceed products plug and play; it also provides energy consumption analysis. All these added values can hardly be realized by separated purchase. In all, the product helps the customers build a green and healthy datacenter quickly.

This chapter expands the model description, specification, features, appearance & components, functional parts, operation condition and environment requirement of the Smart IT Cabin.

### 1.1 Model Description

The model description of the Smart IT Cabin is shown in below table 1-1.

Parameter	Specification		
	SC3000	SC6000	SC10000
System Dimension (LxWxH mm)	600x1200x2075		
Capacity (KVA)	3	6	10
Available IT equipment installation Height	29U/System	27U/System	27U/System
Maximum cooling capacity (KW)	3.5		
Voltage (VAC)	Single Phase, 220VAC/110VAC (Optional)		
Frequency (Hz)	50/60		
Closed mode	cold and hot aisles		
Color	RAL7021		
IP Class	IP5X		

Weight	400kg
Noise	<50dB(Not include)

Table 1-1 Model Description

## 1.2 Features

EverExceed Smart IT Cabin has the following features:

- Dust-proof and noise reduction, high efficiency and energy saving: totally enclosed operation and internal cycle system ensure purity, temperature, and humidity inside the cabinet, to prolong the lifetime of IT devices. A high efficient UPS dedicated for computer room is used, and a precision air conditioner (AC for short) cooperates with closed cold/hot aisle technology to improve purposeful cooling in the computer room. The fan is embedded with mute design, which can be used in an office area.
- Intelligent monitoring: intelligent control functions such as integrated environment monitoring, device monitoring, alarm linkage and so on provide centralized monitoring platform for computer room environment.
- Highly-integrated and space saving: one standard cabinet provides stable operating conditions for all IT devices, only cabinet connection and installing air conditioner are needed in user field. The system only occupies 0.7 m<sup>2</sup>, which is compact and beautiful.
- Friendly HMI and unattended operation: large 7" LCD widescreen display serves you to know the device operation/alarm/safety information. Through the monitoring card embedded in the cabinet, you can realize all day remote monitoring on the mini computer room, to satisfy different occasion application.
- Quick delivery and secure brand: settled at one go, built in one hour, started up during one day, all in EverExceed brand trust with no worry.

## 1.3 Functional Components

The Smart IT Cabin mainly contains a rack supporting system, power supply, and distribution system; air conditioning system, monitoring, and management system, as given Table 1-2

System type	Component	Main function	Feature
Rack supporting system	/	Used to store the 19" rack mount hardware equipment, this complies with the industry-standard (EIA-310-D) such as servers, data, voice, internet network equipment, UPS and so on.	The whole cabinet system is totally enclosed when operating, to keep the system clean without dust, which can save energy and reduce noise.
Power supply and distribution system	PMU(power management unit)	Power distribution, surge suppression	Centralized management over power supply and distribution of the whole system, class C lightning protection
	UPS and battery	Power supply	Providing high-quality electric energy input for IT devices.
	PDU	Power distribution	Configured with Switch model PDU, which can turn on/off output ports intelligently and detect input and output electric quantity parameters.
	LED Lamp	System auxiliary lighting	Safe and energy-saving
Air conditioning system	Air conditioner	Cooling the electronic devices inside the cabinet actively	Small-sized precision environment control system, keep the environment in the cabinet to be stable so that the IT device can operate safely and reliably.
	Emergency Ventilation system	Prevent high temperature partially inside the cabinet	When the system is operating normally the emergency ventilation kit is off; The emergency fan can start up automatically when over temperature occurs inside the cabinet.
Monitoring management system	LCD display panel	Local display and control function	A kind of intelligent management system which provides the monitoring and display of device inside the cabinet; providing text alarming and remote
	PLC and sensors	Environmental and door status collection	
	SMS module	SMS alarm	

			monitoring function for the user.
--	--	--	-----------------------------------

Table 1-2 Functional Components

## 1.4 Operational Environment

Item	Requirement
Installation Position	Make sure that the installation field is level
Installation Field	In computer room or office area, The distance from the front/rear door to the wall or other obstacles is larger than 1.0m
Ambient Temperature	0-40℃
Ambient Humidity	30%RH-95%RH(when the whole unit is operating in high temperature and high humidity environment, condensing water may appear on the external surface of the front glass door and the display panel)
Storage Environment	Indoor, clean without dust
Ambient Temperature	-30℃-70℃
Altitude	1000m, Above 1000m with derate power use

Table 1-3 Operating condition

## Chapter 2 Preliminary Before Installation

This chapter expands the preparation before installing the Smart IT cabin, including installation tools, fittings, accessories, conveying, unpacking, inspection, installation safety instructions and computer room requirement.

### Note:

1. The components of Smart IT Cabin are large and heavy. Therefore, the risk of collapse exists, an improper operation may cause physical injury or death, and damage to the equipment.
2. The center of gravity of Smart IT Cabin is forward-inclined, during the conveying process, not to adjust the bearing position of the forklift or the hand pallet truck.
3. Read all the following operation guides before attempting to move, put up the components or unpack the package.
4. The sharp edge, object sharp angle and bare buckle can result in physical injury. Only trained personnel who wear the proper safety helmet, gloves, shoes and glasses can move and put up the components, remove the package or prepare to install.

- The cabinet may be too high to go through the door together with the pallet. To avoid damage to the equipment and the building, measure the height of the cabinet, and the door, and confirm the clearance before moving it.

## 2.1 Conveying, Unpacking and Inspection

### Transportation

It is recommended to choose a railway or ship for transporting the cabinet, AC indoor unit, and AC outdoor unit. If truck transportation is chosen, choose preferable roads to avoid excess bumping.

The component with a package is shown in Figure 2-1. See table 2-1 for its ranges of dimensions and weight.

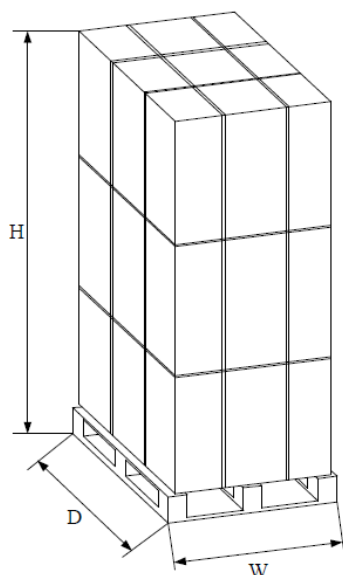

Figure 2-1 Component with package

Table 2-1 Range of dimensions and weight

Component	Range of dimension (mm)			Weight (Unit: kg)
	H	W	D	
Cabinet component with package	2250	720	1400	450kg

### Carrying

The user needs to carry the cabinets, closed frames and AC indoor unit to the nearest place to the installation site because they are heavy, it is recommended to use mechanical carrying tools to unload and carry them, such as a hand pallet truck or an electrical forklift, as shown Figure 2-2

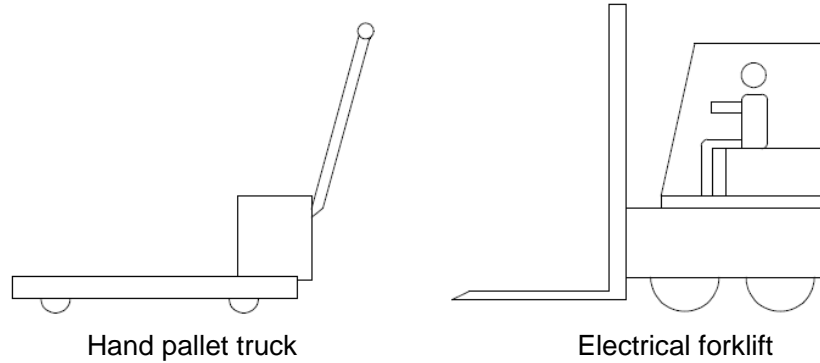

## Unpacking

Move the equipment to the nearest place to the final installing site, and then unpack it.

The unpacking procedures are as follows:

1. Remove the packing materials
  - 1) Move the equipment of assembled package to an open, firm and level ground.
  - 2) Use a utility knife to cut off the packing strip on the package paper box carefully and remove the package paper box of the cabinet.
  - 3) Use a utility knife to remove the extension film on the cabinet and the bagging package materials
2. Remove the feed pressure plate

Use a sleeve or a moveable wrench to remove the fixing screws on the pallet, and remove the pressure plate, as shown in Figure 2-3

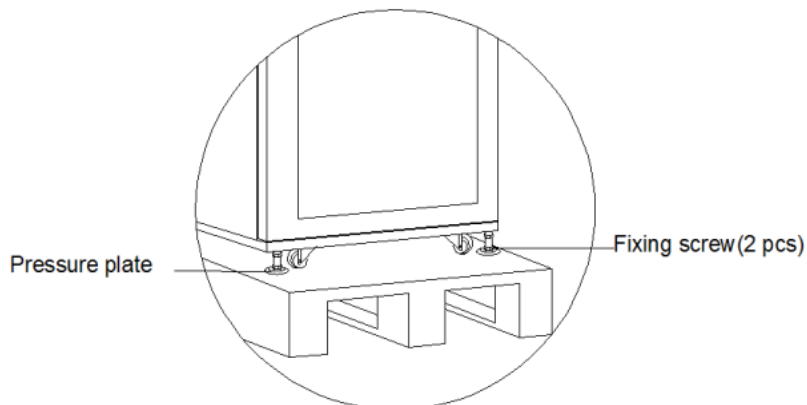

Figure 2-3 Removing the feet pressure plate

### 3. Remove the pallet and installing cabinet components

- 1) Place a slope in the front or rear door of the cabinet and connect with the pallet
- 2) Push the cabinet slowly from the pallet down to the ground along the slope
- 3) Place the cabinet on the preserved position, and adjust the feet fixing nut till the cabinet is level.

#### Note

1. When the removing the pallet, you need to prepare the slop or similar device by yourself.
2. The whole cabinet is very heavy, so take precautions when pushing the cabinet from the pallet down to the ground along the slope to avoid accident collapse.

#### Weight-bearing capacity

The Smart IT Cabin is heavy, so you should consider the weight-bearing capacity of the floor of the computer room. The cabinet body of Smart IT Cabin is 400Kg, occupying 0.72m<sup>2</sup>. During actual engineering installation, you need to estimate the weight-bearing capacity of the floor according to the total weight including the installed pieces of equipment. If you can not estimate the weight-bearing capacity, please consult the local EverExceed agent or EverExceed customer service office.

## 2.2 AC Installing

### 2.2.1 Instructions

Do not use the device at a high-temperature dust, oil, humidity, corrosive gases in harsh environments. Among them, the ambient temperature shall not be higher than 45 °C, the humidity shall not exceed 85%, and starting running voltage shall not exceed 10% of rated voltage or less than 10% of rated voltage.

We must ensure that the air conditioning smoothly drainage, exposed pipes outside the cabinet cannot tilt or trap, so as not to affect drainage.

#### Safety Alert:

- 1) Follow by the manual operation before installation. Otherwise, improper installation may result in compromised leak accidents, electrocution, fire, equipment loosening

- 2) Air conditioning is prohibited to be pressed, heating, plugging power line and water pipe.
- 3) When cleaning, disassembling or servicing equipment, first cut off the power supply to avoid electric shock and other accidents.
- 4) When an exception occurs (smoking, abnormal sound, not work after starting up for a long time, etc.), immediately turn off the power to stop operation of the equipment, meanwhile call Professional overhaul.

### 2.2.2 Outside machine wiring diagram (Figure 2-4)

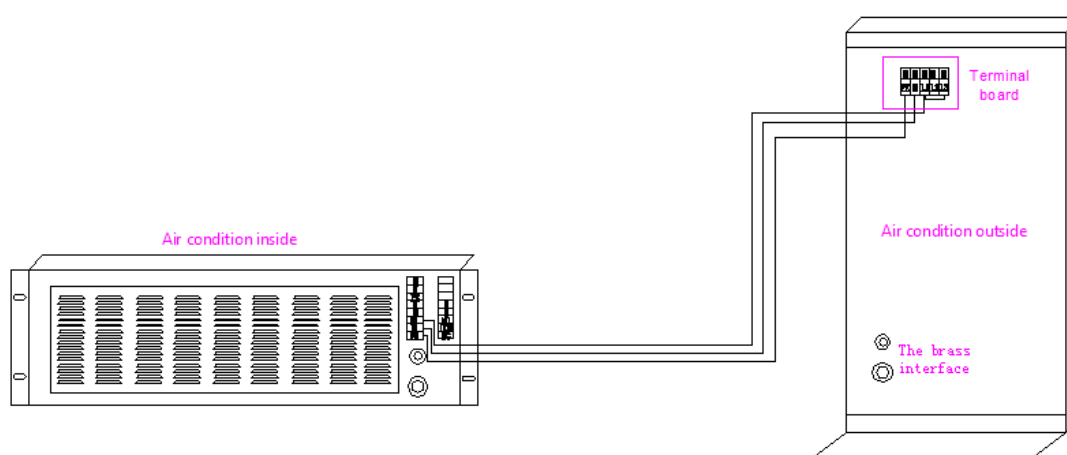

Figure 2-4 wiring diagram (detail in CAD drawing)

### 2.2.3 Connecting Copper Pipes

#### 1. General Principles

- 1) Use copper pipes with a quick thread connector to connect the indoor unit and the outdoor unit. If the pipe length exceeds the standard pipe length and a straight copper pipe is used, piping joints must be brazed.
- 2) Follow standard industry procedures in selection and placement of pipe, system evacuation and charging with refrigerant (only when the pipeline is too long).
- 3) Give considerations to pipeline pressure drop, oil return to the compressor, to avoid oil leakage and clogging in parts of the system and minimize noise and vibration to the greatest extent.

#### 2. Installation notes of the connectors

The connectors of the unit are located on the AC indoor unit and outdoor unit

and on top of the cabinet. Be careful when connecting the quick thread connector. Read through the following steps before making a connection.

- 1) Remove the dust-proof caps.
- 2) Carefully wipe coupling seats and threaded surface with a clean cloth.
- 3) Lubricate the male thread with refrigerant oil.
- 4) Thread the coupling halves together by hand to ensure that the threads mate properly.
- 5) Tighten the coupling body's hexagon nut and union valve until a definite resistance is felt.
- 6) Use a marking pen to draw a line lengthwise from the coupling union nut to the bulkhead. Tighten the nuts an additional quarter turn with two wrenches. The misalignment of the lines shows how much the coupling has been tightened. The final quarter turn is necessary to ensure that the joint does not leak. Two wrenches must be used to cooperate with each other during connection because one wrench can damage the coupling copper lines easily.

## Chapter 3 Operation instructions

### 3.1 Check before Startup

Check the following before startup of Smart IT Cabin:

1. Check whether the AC pipe system is connected correctly and firmly, and there is no leakage.
2. Check and confirm that the power distribution mode of UPS and PMU, connections of the power cables and the signal cables are correct and that there is no short circuit.
3. Check that the installation and cable connection of the batteries are correct and that the positive pole and negative pole of the battery are correct.
4. Measure and check that the voltage and frequency of the mains are normal.
5. Check and confirm that all of the communication cables are connected

correctly and firmly.

6. Check and confirm that the remained unoccupied U height space is covered by the dummy plate.

## 3.2 Startup

The startup procedures are as follows:

1. Close the external input power switch.
2. Close the input air breaker downstream the UPS.
3. Close the main input air breaker on the MSC-PMU, SPD module air breaker, UPS input air breaker, AC input power air breaker, UPS output air breaker, lighting & LCD air breaker from left to right in turn
4. The AC is powered directly by the mains. After the power input air breaker is closed, wait for about 5s, the AC inner fan will start up.
5. After the UPS is powered on, it enters self-test state (including battery self-test), all LED indicators blink and the beeper beeps discontinuously. After the self-test, the UPS will enter the standby mode, and the MAINS indicator will turn on, as shown in Figure 4-3 (a). Press the ON/SILENCE key for above 1s, and wait for about 30s, the UPS will switch to inverter standby mode, and the INVERTER indicator will blink. When the UPS has output, the INVERTER indicator will turn on.
6. Measure whether the inverter output voltage is normal.
7. After the UPS inverter output becomes normal, the LCD on the front door will get power and startup. Log in the Smart IT Cabin monitoring system.
8. Open the front and rear doors, observe whether the LED indicators can turn on.

## 3.3 Power off

The power-off procedures are as follows:

1. Ensure that all user IT equipment is powered off.
2. Enter the Hot Management menu of the LCD monitoring system to turn off the AC.
3. After the AC stops flowing cold wind, open the AC air breaker on the

- PMU.
4. Press the OFF key on the display panel of the UPS.
  5. Open the UPS input and output air breakers.
  6. Open the total input air breaker on the PMU.
  7. Check that all the equipment is powered off, and close all the doors of the cabinet.

## Chapter 4 Operation on Display Panel

### 4.1 The Smart IT Cabin Homepage

The Smart IT Cabin Homepage is shown in Figure 4-1.

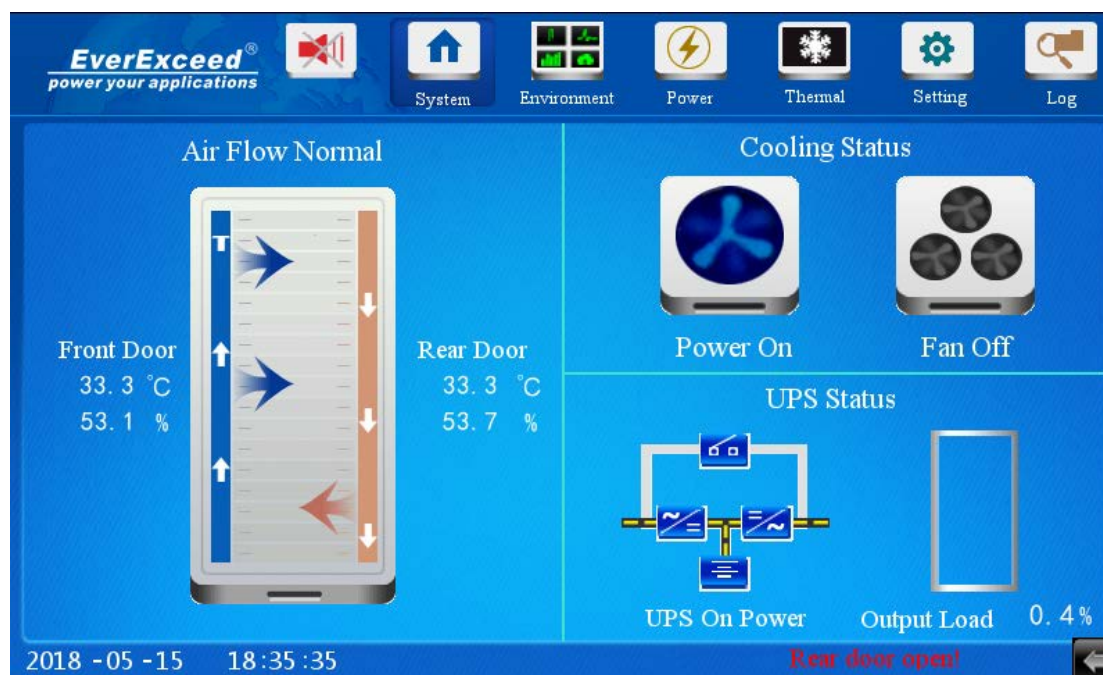

Figure 4-1 Home page

On the Smart IT Cabin Homepage, the menu items include System, Environment, Power, Thermal, Setting and Log.

The system menu structure of the display panel is shown in Figure 4-2.

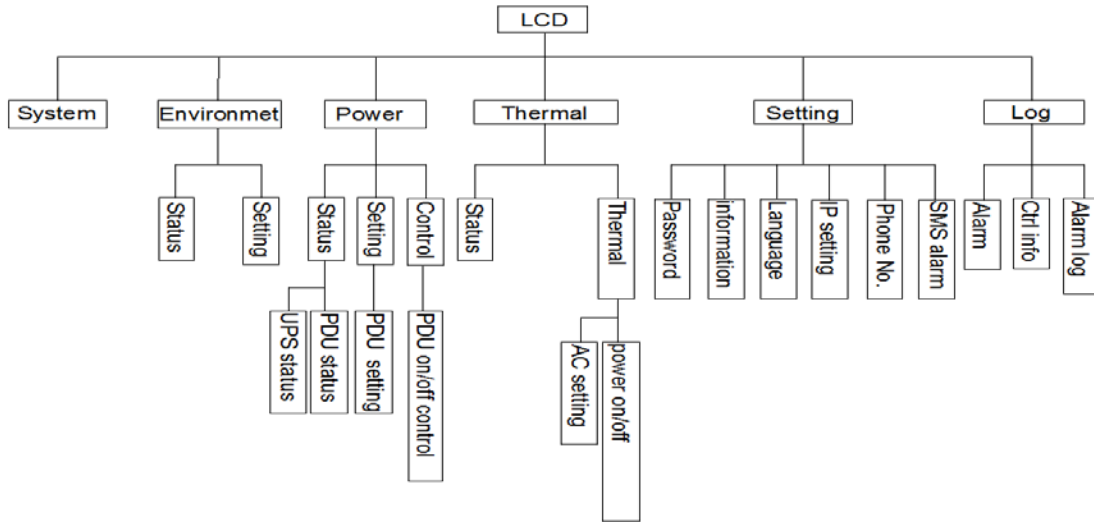

Figure 4-2 System menu structure of Smart IT Cabin

## 4.2 Menu items

### 4.2.1 Main information of Smart IT Cabin

On the display screen, click the System menu at the upper part, the system page will appear, displaying air flow status, cabinet cold aisle temperature, hot aisle temperature, AC status and UPS status, as shown in Figure 4-3.

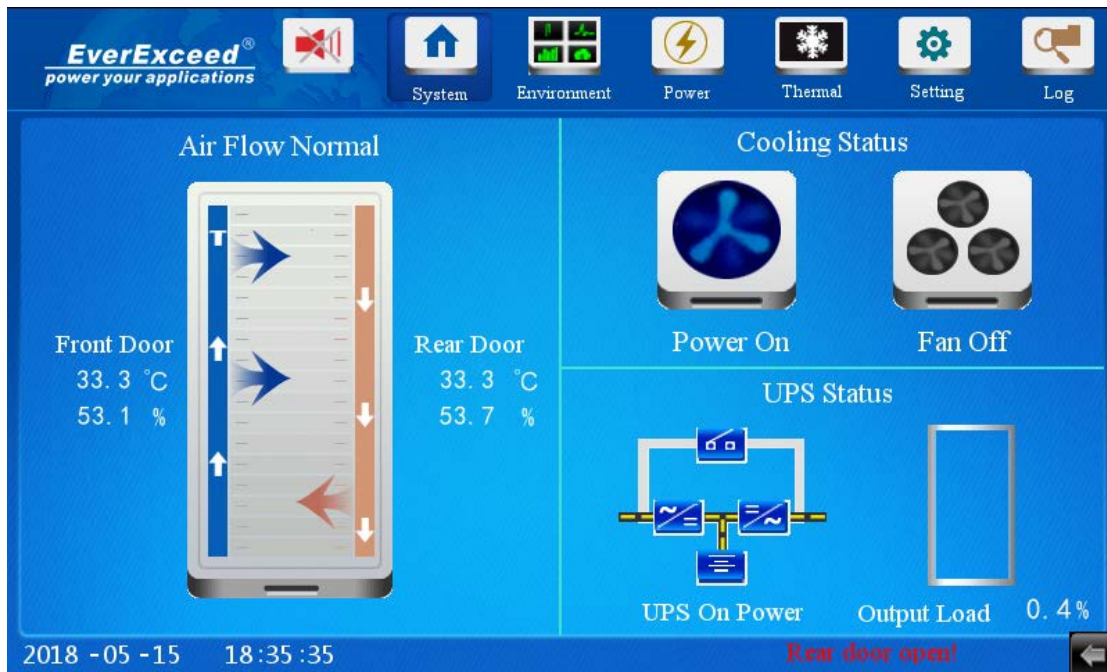

Figure 4-3 Menu

The system page is divided into four parts, the left part displays air flow cycle mode of Smart IT Cabin, front door temperature and rear door temperature; the upper right part displays thermal management mode inside the system, including AC on/off status and emergency fan on/off status. The lower right part displays UPS working mode and real-time load percentage of the system.

#### 4.2.2 Environment

Click the Environment menu at the upper part, the status page will appear, as shown in Figure 4-4

The curve displays the front door temperature and rear door temperature within one hour in real time: the right part displays front door on/off status, rear door on/off status, water leakage status and fog status. When there is an open flame, will automatically trigger the internal fire extinguishing system to outfire.

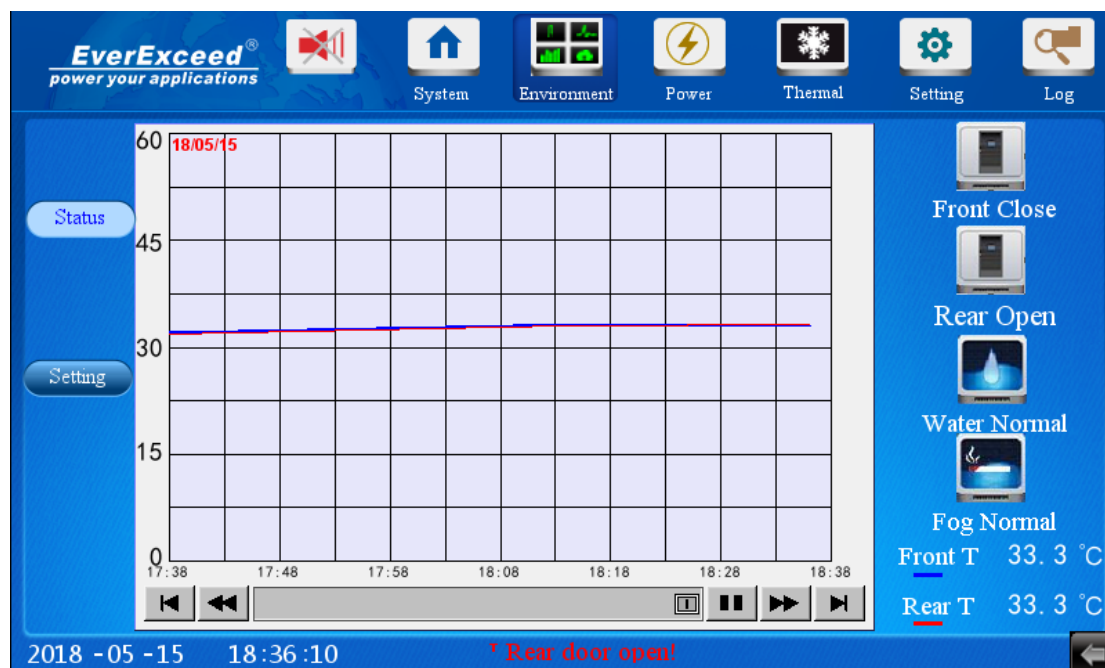

Figure 4-4 Environment

Clicking the Setting submenu can view the setting signal of environment temperature. In Figure 4-5, you can set parameters of intelligent temperature sensors. For example type a setting valve in the field of High Temp Threshold, the setting range is 0 ~ 30.0.

Press the valve edit box, a digit keyboard will pop up, type the valve you want to set, and click the Enter button on the digit keyboard, as shown in Figure 4-6, the typed valve will be sent to the device.



Figure 4-5 Environment temperature (setting)



Figure 4-6 Example of setting valve

The default values of temperature alarm are as follows:

The alarm upper limit of front door temperature sensor is 35°C, and the alarm lower limit is 0°C; the alarm upper limit of rear door temperature sensor is 45°C, and the alarm lower limit is 0°C; the temperature alarm hysteresis is 1°C.

#### 4.2.3 Power

Click the Power menu at the upper part of the page, the status page will appear, as shown in Figure 4-7.

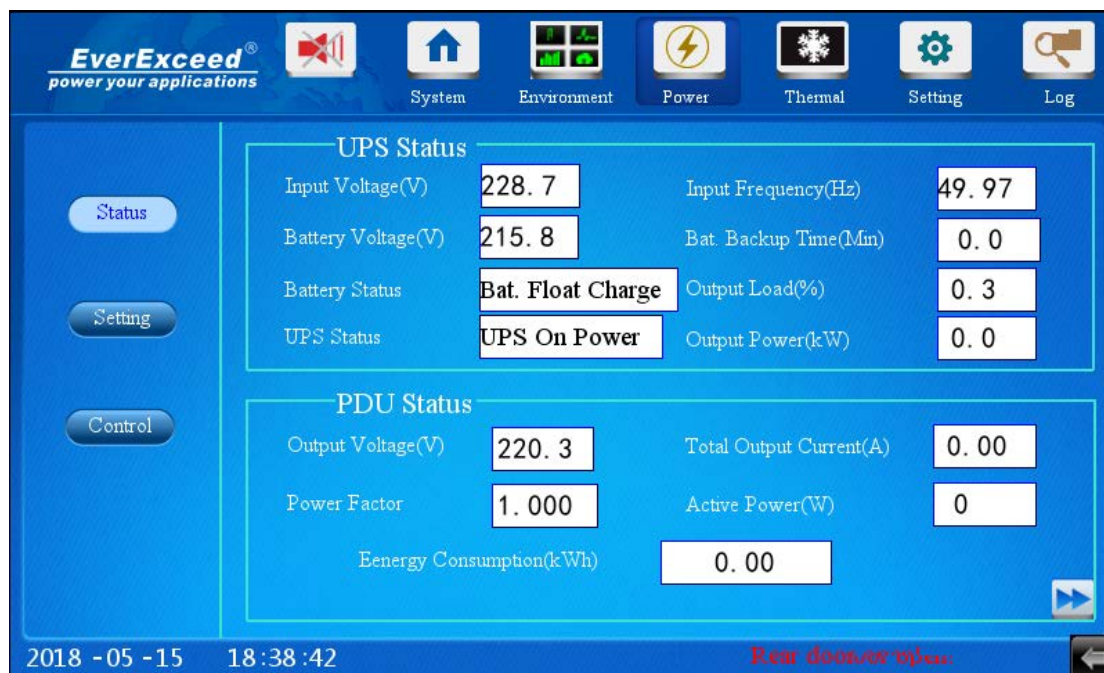

Figure 4-7 Power Status Page(1)



Figure 4-8 Power Status Page(2)

Click the setting submenu in the left part, the setting page appears, as shown in Figure 4-9. The setting operation is the same as that of environment temperature.

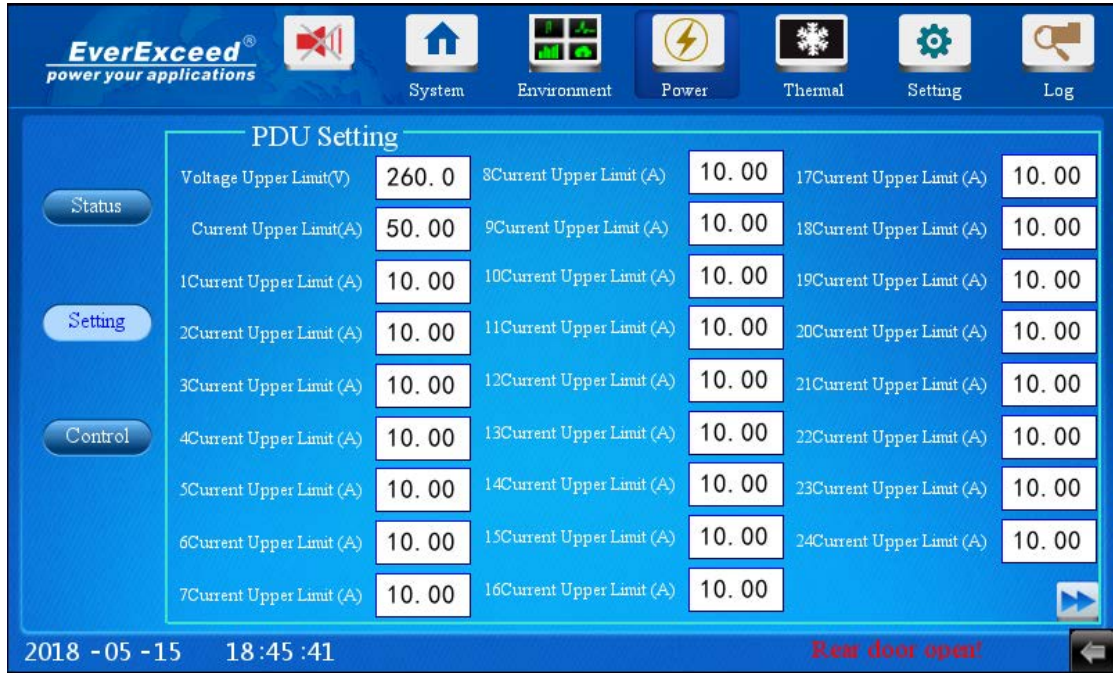

Figure 4-9 Power Setting Page

Click the control submenu in the left part, the control page appears, as shown in Figure 4-10.

You can realize on/off control over each place of the PDU by clicking the OFF/ON icon. When the icon is green and displaying ON status, it indicates that the PDU output status is ON; when the icon is grey and displaying OFF status, it indicates that the PDU output status is OFF.

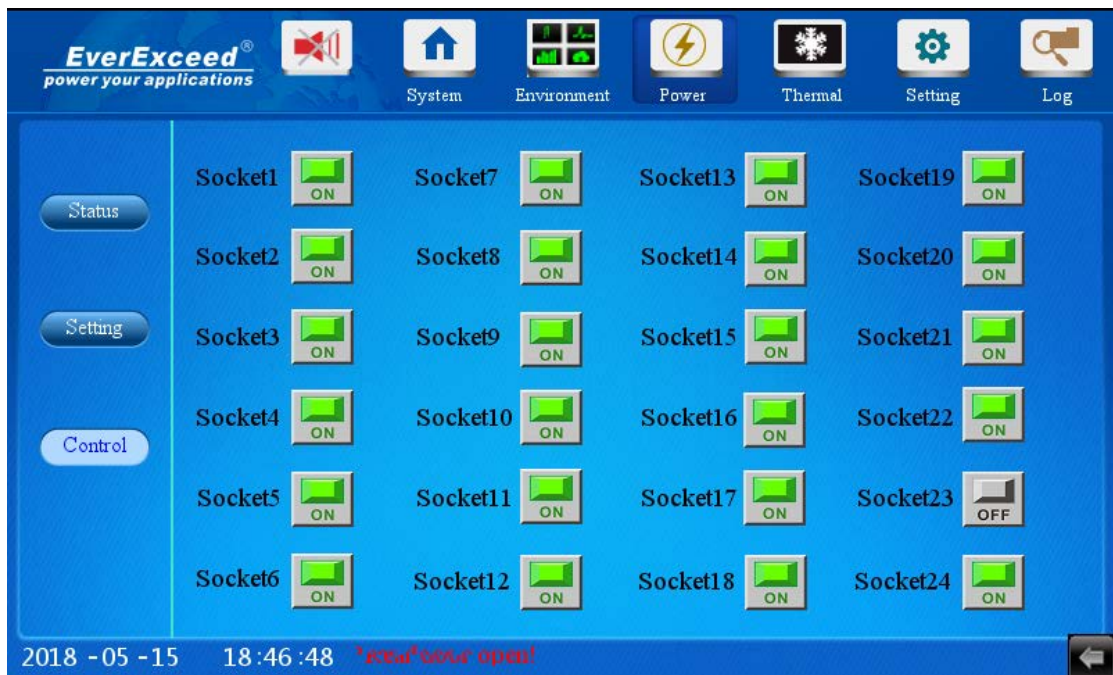

Figure 4-10 Power Control Page

#### 4.2.4 Thermal

Click the thermal menu at the upper part of the page, the status page will appear, as shown in Figure 4-11

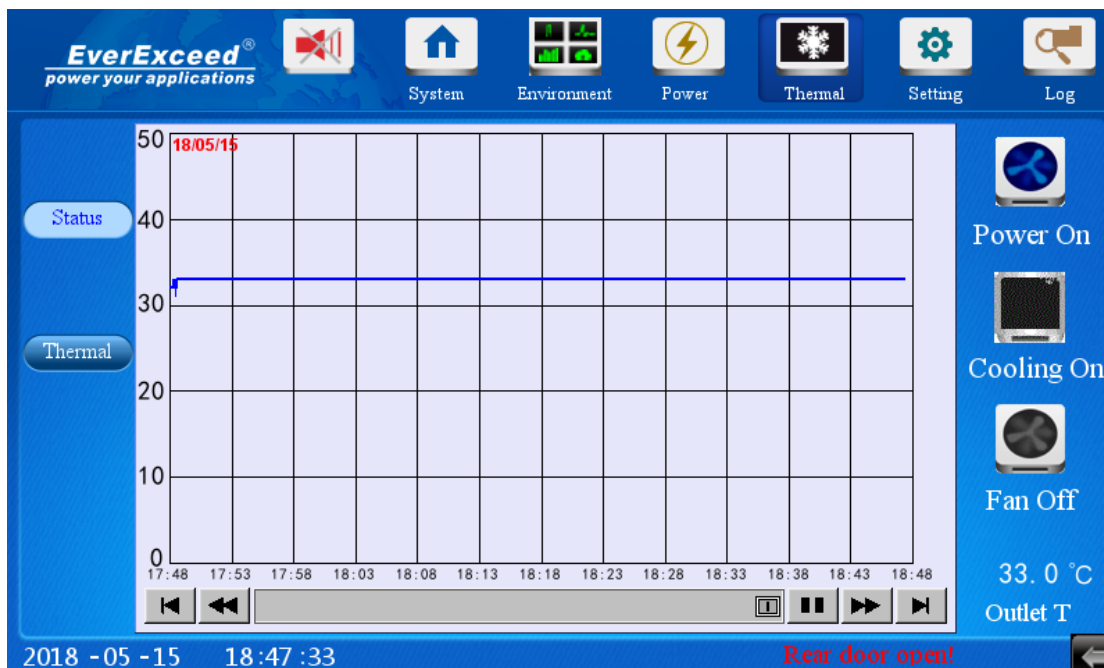

Figure 4-11 Thermal Status Page

Click the thermal submenu at the left part, the thermal page will appear, as shown in Figure 4-12. You can click the OFF/ON icon in the Power On/Off filed, to realize AC on/off control in the Smart IT Cabin. The control and operation mode of AC on/off is the same as that of power control; environment temperature.

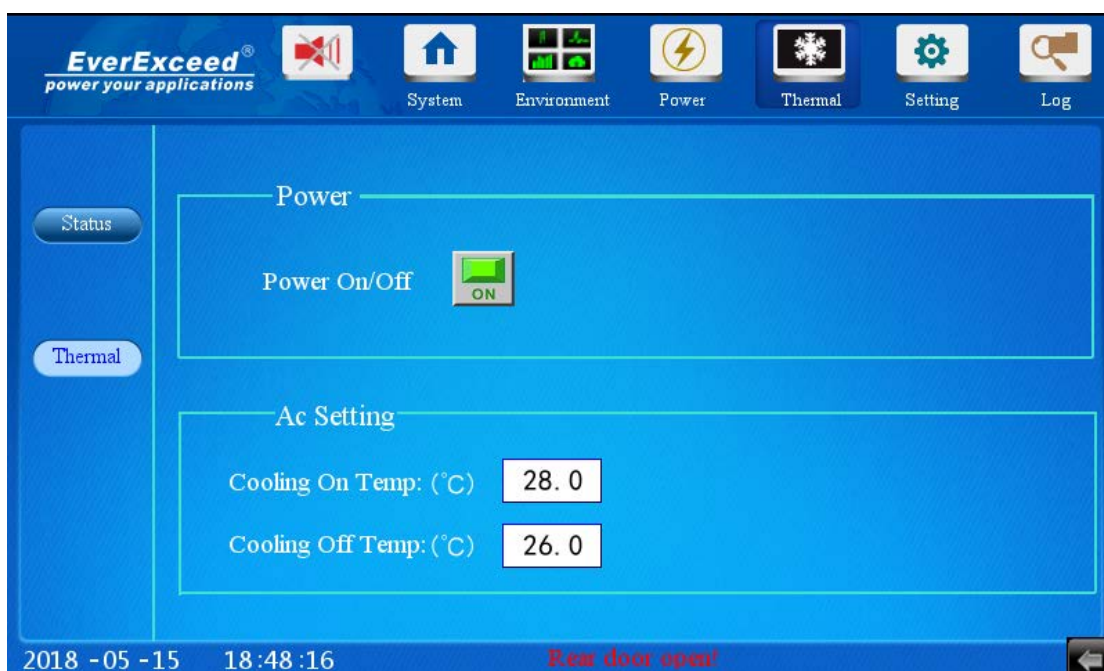

Figure 4-12 AC Management Page

#### 4.2.5 Setting

On the Smart IT cabin display panel, click the Setting menu on top of the page, six submenus appear, including Password setting, System Information, Language setting, Web setting, Alarm Telephone Setting, Message Alarm Setting Password.

##### Password Setting

Click the Password submenu under the Setting menu, the page shown in Figure 4-13

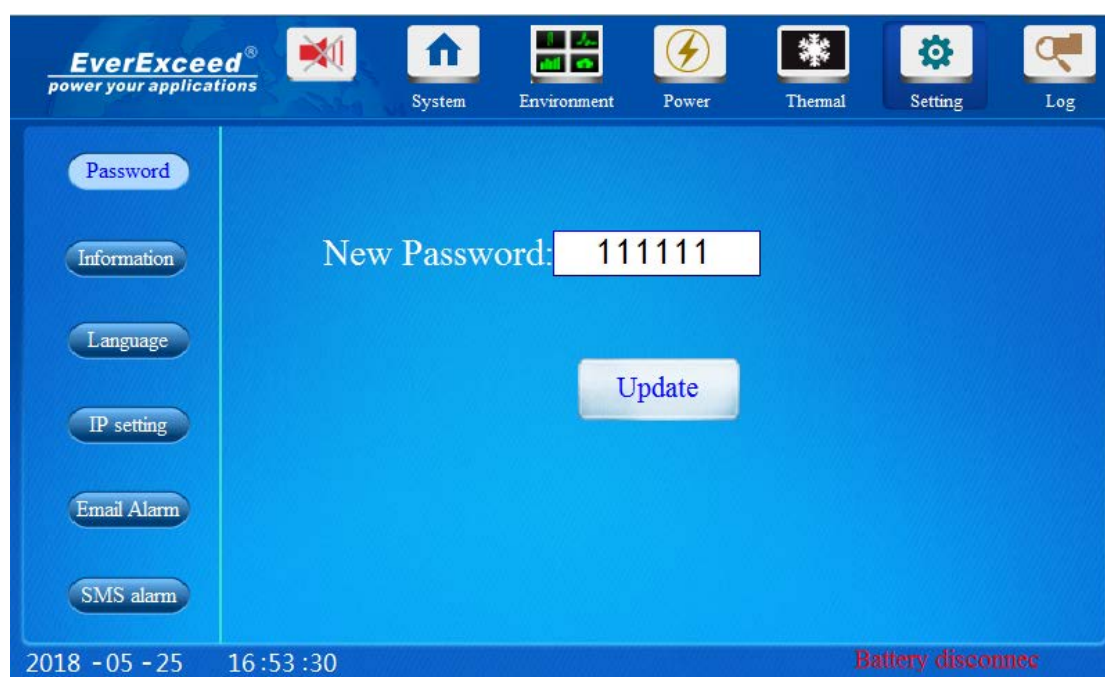

Figure 4-13 Password Setting

##### System Information

Click the Information submenu under the Setting menu, the page shown in Figure 4-14. The system name hardware version software version and product serial number available checked on this page.



Figure 4-14 System Information

## Language Setting

Click the Language setting submenu under the Setting menu, the page shown in Figure 4-15. Chinese, English available choice, other languages available to add as option.



Figure 4-15 System Information

## Web Setting

Click the Web setting submenu under the Setting menu, the page shown in Figure 4-16. You can set an IP address, gateway and port number.

With EasyAccess 2.0 software could realize the remote monitoring



Figure 4-16 IP setting

## Email Alarm

Click the Email Alarm sub-menu under the Settings menu, (the interface shown in figure 4-17) .

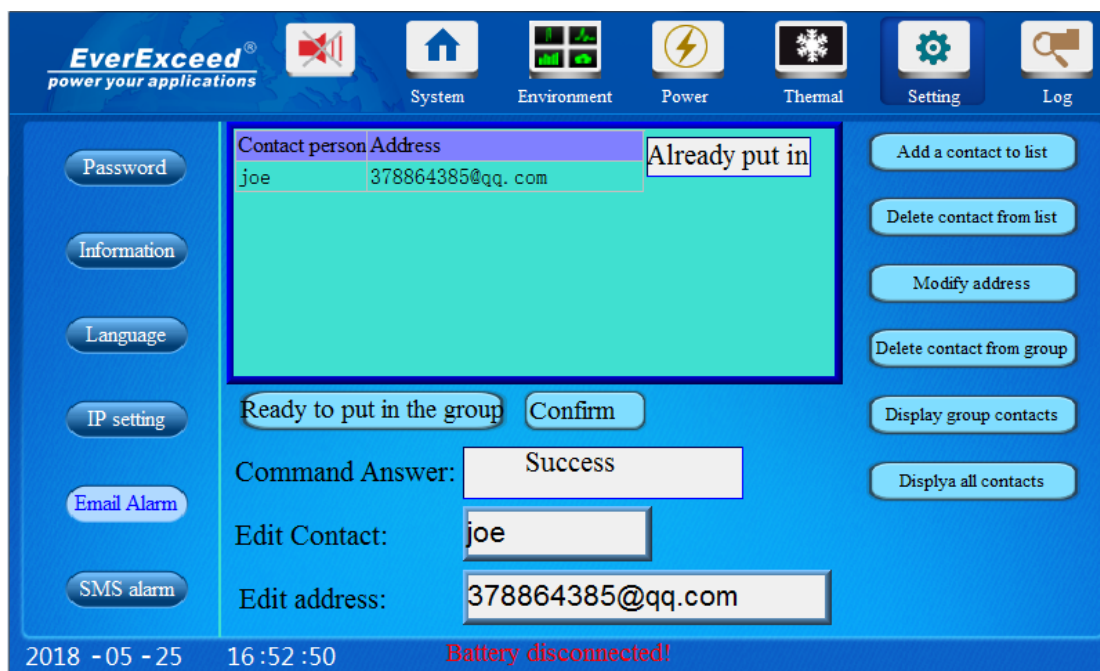

Figure 4-17 email alarm setting

### Description of Email Alarm Settings:

- 1. As shown in the figure, enter the contact name in the Edit Contact box. In the Edit address box, enter the mail address that needs to receive the alarm. When finished, click the "add a contact to list" button in the upper right corner of the figure. The added contacts are shown in the diagram. Click the "delete contact from the list" button, you can choose to delete the contacts in the list. If additional contact adding is required, new input is required.
- 2. Select the added contacts in the diagram, Click the "ready to put in the group" button, Click the "confirm" button again. At this point, new contacts are displayed in the group. You can receive emails normally. A contact that is not placed in the group cannot receive emails.
- 3. Click the "display group contacts" button, Displays the contacts that have been placed into the group. Click the "delete contact from the group" button, you can choose to delete the contacts that have been placed in the group. It will not be removed from the list. If you need to regroup a contact from a group, Click the "display all contacts" button, Select the deleted contact, click the "ready to put in group" button, Click the "confirm" button again.
- 4. If the contact name or email address entered is incorrect. You can select the contact in the list, Re-enter the correct contact name or mail address in the corresponding box, Click the "modify address" button again.

### SMS alarm

Click the SMS alarm sub-menu under the Settings menu, the interface shown in figure 4-18. You can set 5 phone Numbers. Enter the mobile phone number that requires SMS alarm and tick on the right side to finish the process. Click the lower right arrow in the figure to enter the alarm selection Settings, (the interface shown in figure 4-19) Tick on the right box after the corresponding alarm.

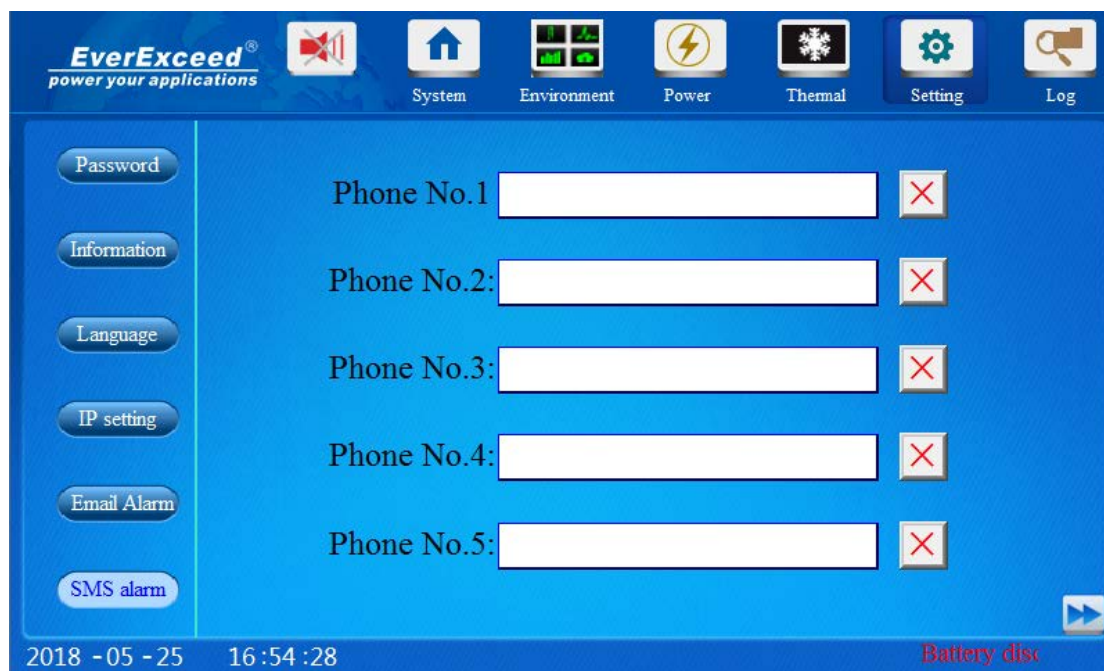

Figure 4-18 SMS alarm setting 1

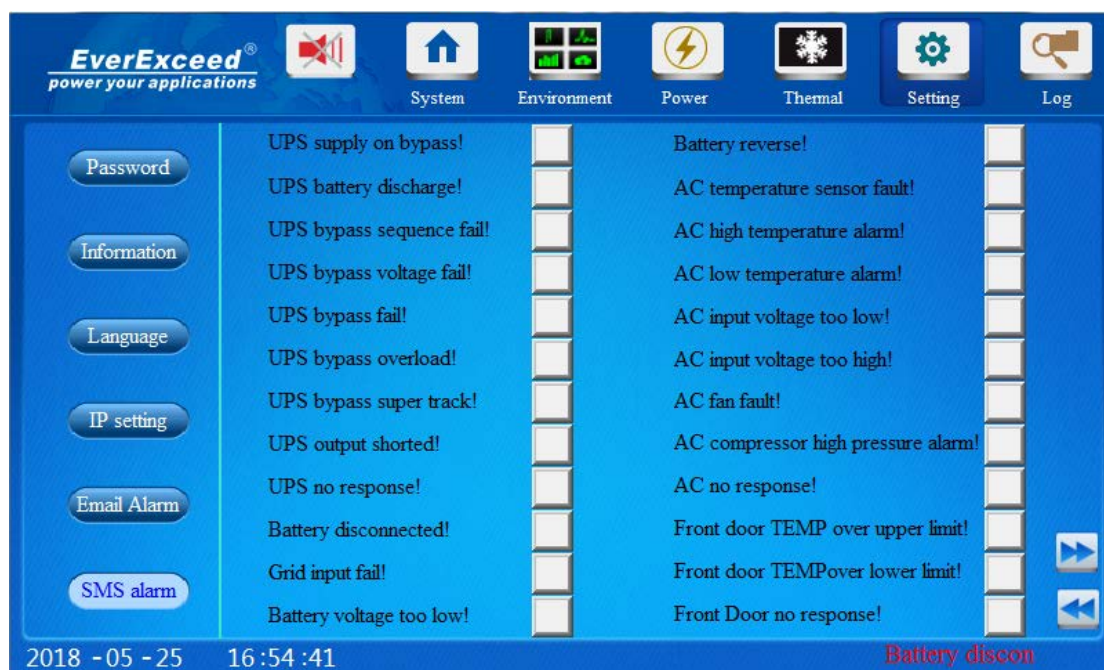

Figure 4-19 SMS alarm setting 2

Message Alarm setting including all the alarm contents, if need any Alarm item, tick in behind of the Alarm item.

#### 4.2.6 LOG

##### Alarm Management

##### 1. Display an Alarm

On any page, if the current system has an alarm, in the lower part of the page, the red word will appear to display the current alarm, as shown in Figure 4-19.

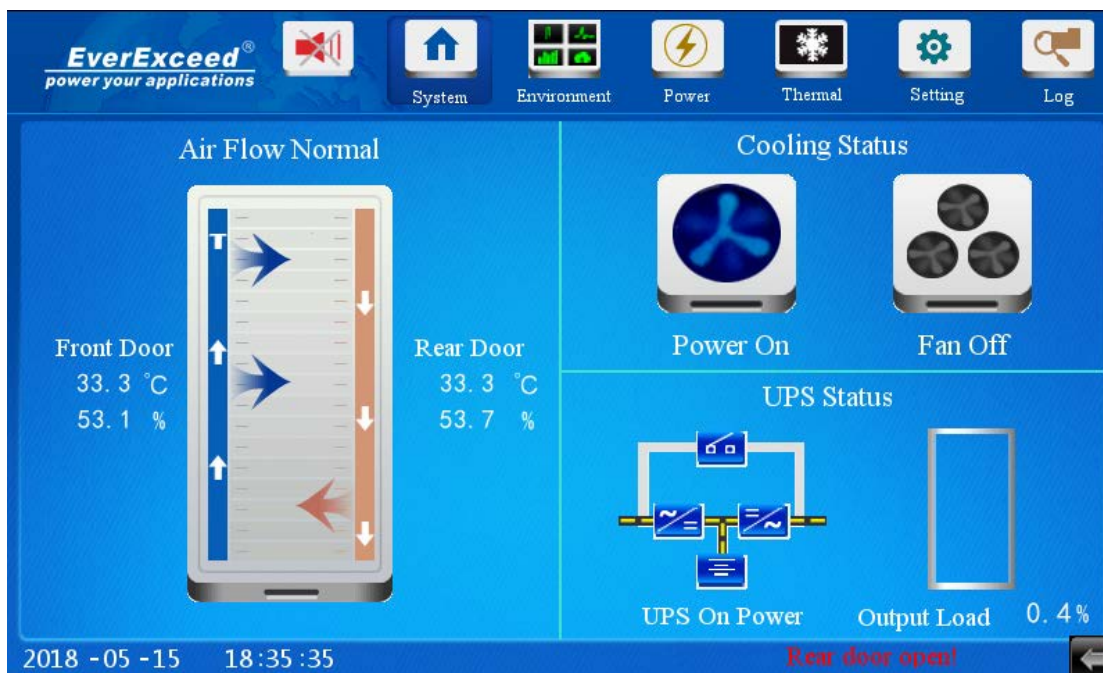

Figure 4-19 Alarm Information

When the system has an alarm, there will be an alarm sound. If you want to turn off the alarm sound, click the Alarm button.

Click the Log menu on the submenu, you can check and view current Alarm Alert, as shown in Figure 4-20. You can view historical alarm record and historical control record in this page. as shown in Figure 4-21 and 4-22.

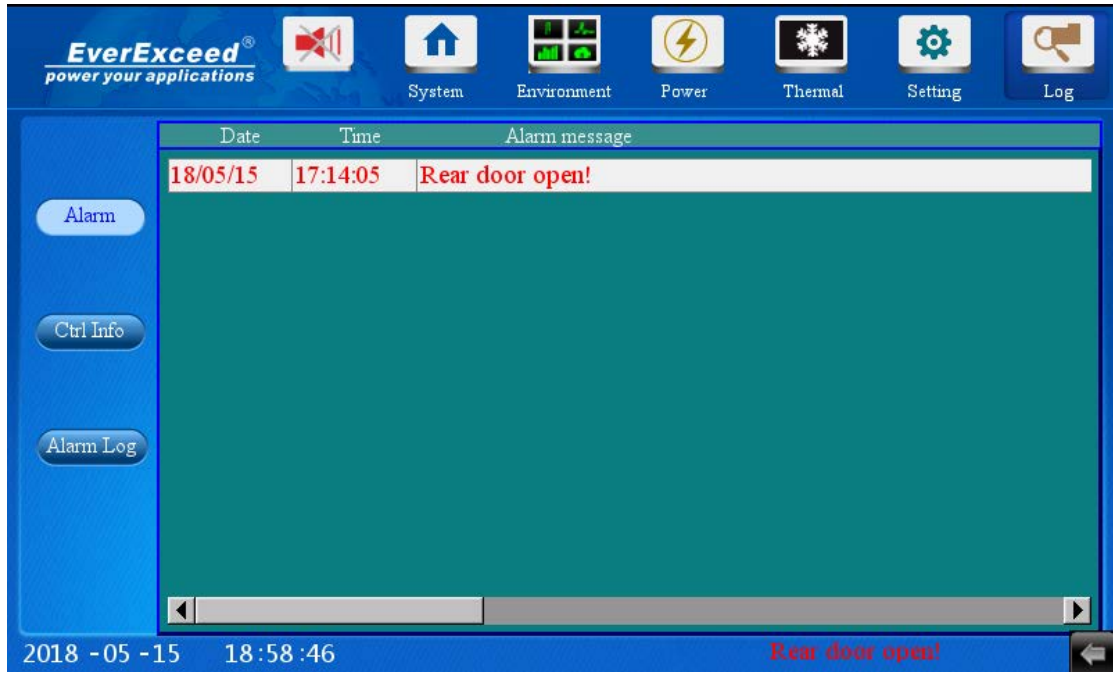

Figure 4-20 Log information

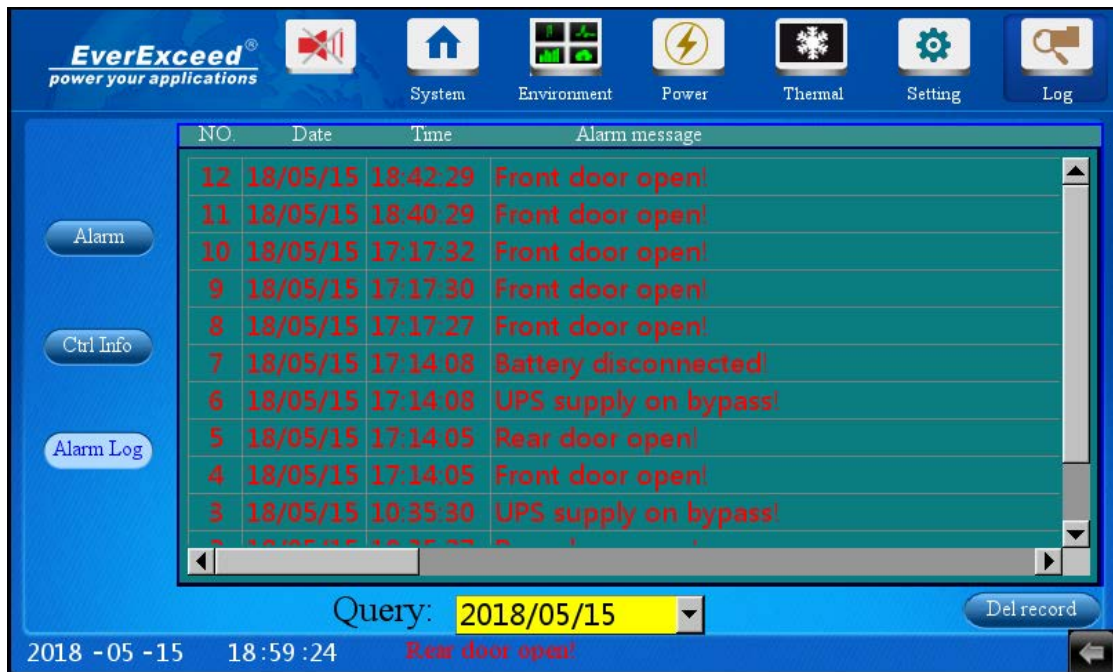

Figure 4-21 Historical Alarm Page

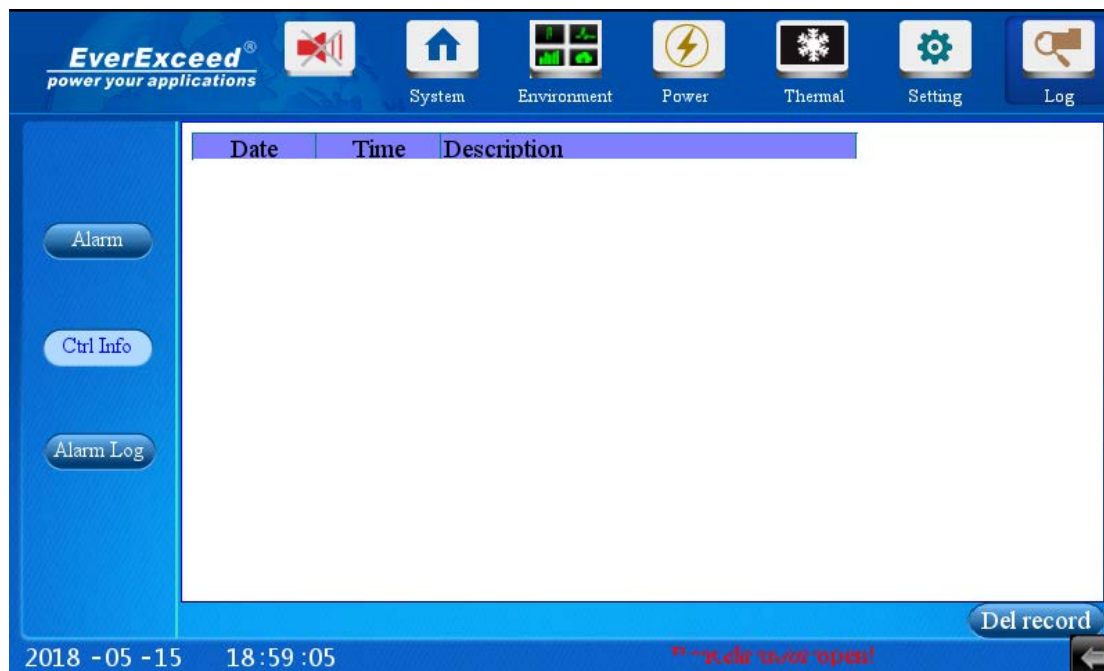

Figure 4-22 Control Page

### 4.3 Remote Control

This system provides a new solution for remote monitoring. No matter where the equipment is located, its operation can be monitored as long as the Internet is available, so the trouble or faulty can be known and solved for the first time. It's very easy for users to connect the monitoring system, just like they connect to the local network. Moreover, the users can connect multiple devices simultaneously. The remote interface is the same as the touchscreen display, as shown in figure 4-23.

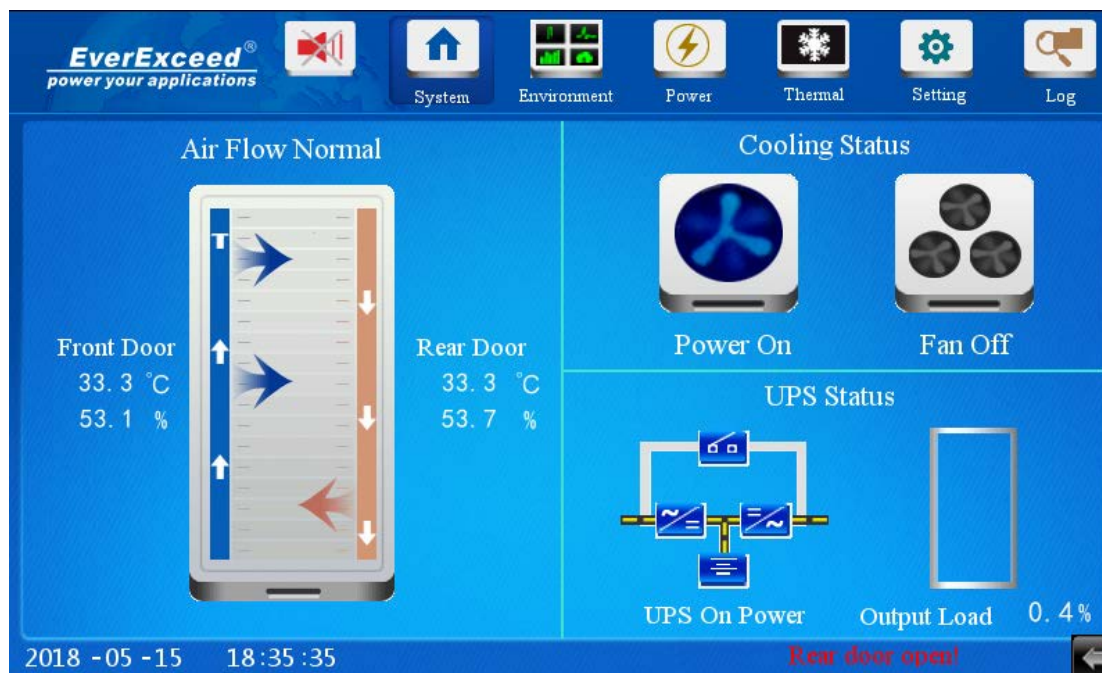

Figure 4-23 Remote Control

#### 4.3.1 The way of remote control

Before the remote control, you need to install Easyaccess 2.0 and EsayBuilder Pro software on your PC, then log in the Easyaccess with Domain account and password. Soft waft icon is shown in Figure 4-24



Figure 4-24 Soft waft icon

Step 1: Enter the Web setting submenu under the Setting menu of the touch screen, click “ EasyAccess 2.0” Button, the page shown in Figure 4-25. Then click start, it will show “ success” if connect successfully.



Figure 4-25 EasyAccess2.0 interface

Step 2: Login on EasyAccess 2.0 software on your PC, enter the Domain account name and password, the page shown in Figure 4-26.

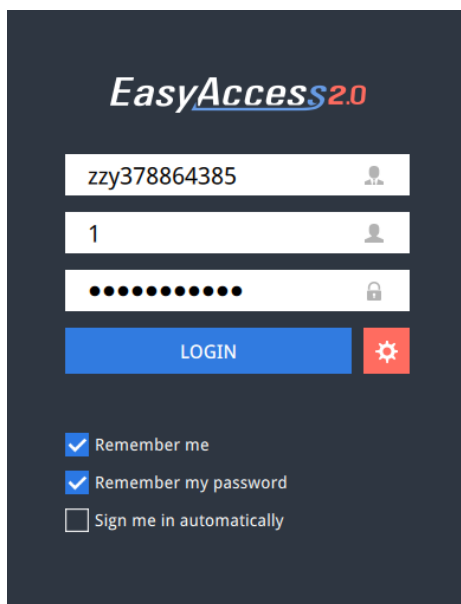

Figure 4-26 Login Page

Step 3: After login account successfully, the page shown in Figure 4-27. The user can manage multiple devices as shown.

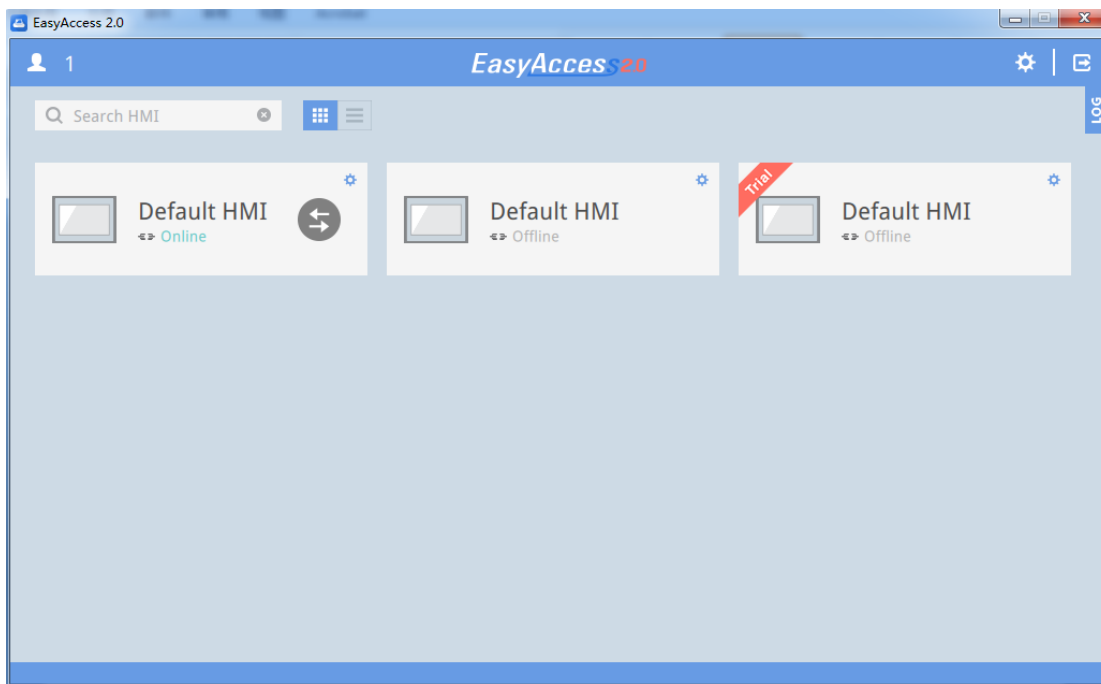



Figure 4-27 connect interface

Step 4: After on-line, click “” icon to enter the remote control page, and then click the black dot as shown in Figure 4-30, you can enter the major interface to realize the remote control.

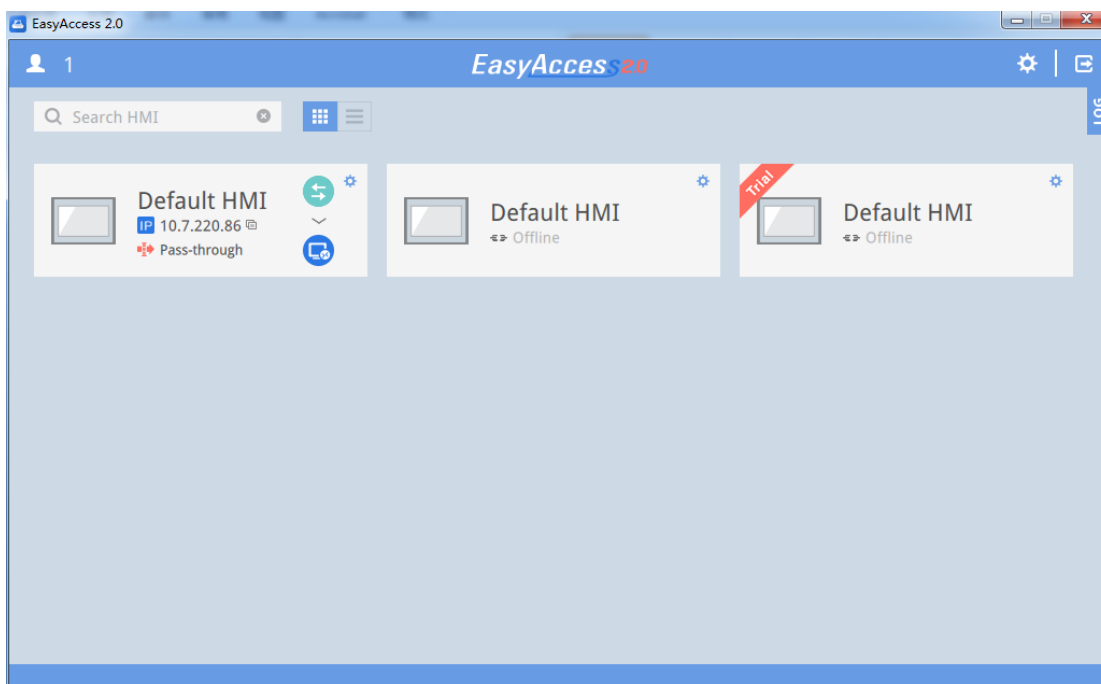

Figure 4-28 connect interface

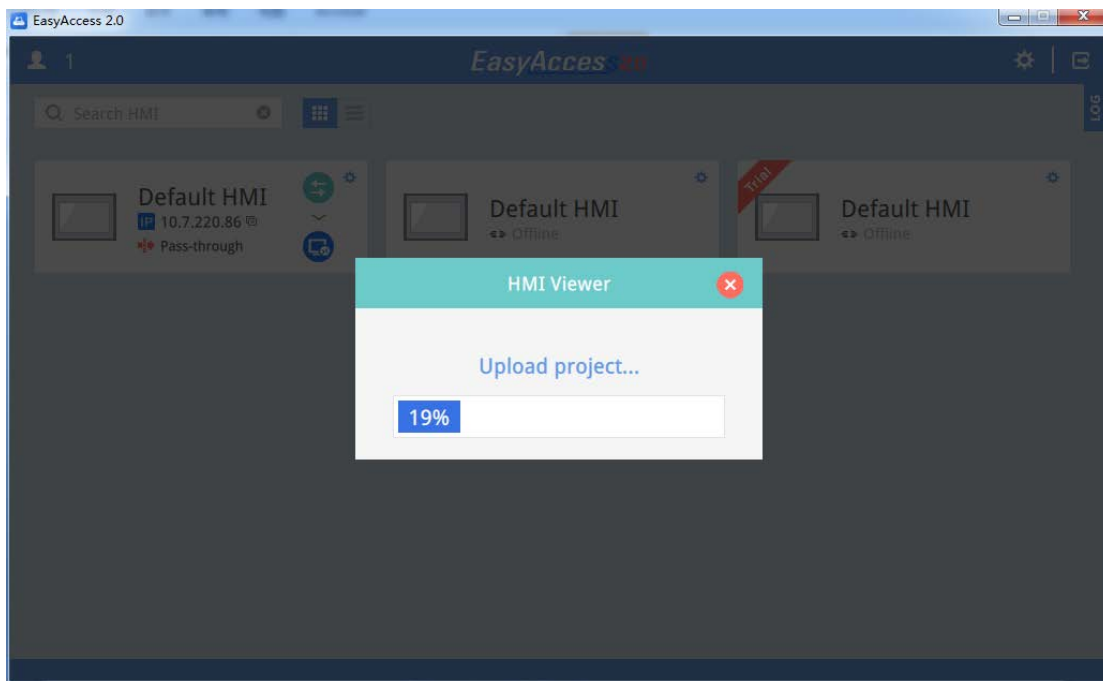

Figure 4-29 connect interface

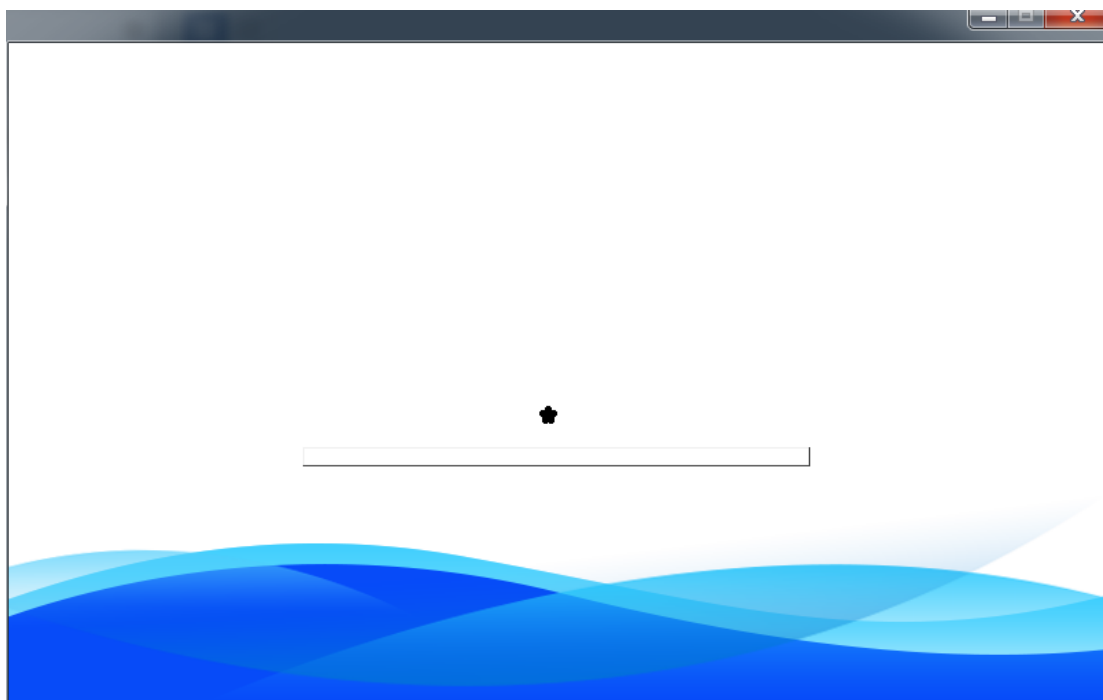

Figure 4-30 connect interface

## Chapter 5 Maintenance

This chapter expounds the maintenance of Smart IT Cabin, including safety instruction, maintenance of the main components, disassembly and troubleshooting.

### 5.1 Safety Instruction

---

1. Switch off the power input during the equipment maintenance. Switch off the equipment power unless the testing device needs power
  2. Only authorized professional technicians are allowed to maintain the system
- 

1. All maintenance and operation must follow the local laws, especially the regulations about the electric power, refrigeration and production
2. Comply with the manufacturer instructions during maintenance. Failure to observe this could result in invalidation of warranty
3. Ignoring the safety instructions will endanger personal safety and the environment.
4. Unsuitable components will lead to a performance decrease or equipment shutdown, it is commanded to use the components made by EverExceed.

### 5.2 AC System Maintenance

The AC system maintenance includes electric inspection, indoor unit maintenance, and outdoor unit maintenance.

**Note:** Switch off the circuit breaker and cut off the unit power before maintenance unless the power is necessary for the commissioning item.

#### 1. Electric inspection

Visually inspect the control board, the temperature sensor on a semi-annual basis for any loose electric connection and circuit corrosion.

Inspect the boards one by one according to the procedures below:

- 1) Do unit electric insulation test to find failed contacts and deal with them.
- 2) Tighten all electric contacts.
- 3) Clean the electric and control components with a brush or compressed

dry air.

## 2. Indoor unit maintenance

### 1) Fan

Since the fan kit operates 24 hours every day continuously, any unusual airflow obstruction must be cleared in time to avoid the damage to the cooling system and other system components caused by reduced air volume.

### 2) Drain pipe

Inspect water pan periodically for normal operation of the drain pipe. Ensure that no foreign matter or leakage exists in the drain pipe.

## 3. Outdoor unit maintenance

### 1) Refrigeration system

The components of the refrigerant system should be inspected monthly for finding abnormal operation phenomenon in time. Refrigerant pipes must be properly fixed and not allowed to vibrate against the wall, floor or the unit frame. Inspect all refrigerant pipes every six months for signs of wear.

### 2) Air-cooled condenser

When the airflow through the outdoor unit is restricted, use compressed air or fin cleaner (alkalinescence) to clean the condenser off the dust and debris that inhibit airflow. The compressed air should be blown at the reversed airflow direction. In winter, do not let snow to accumulate around the side or underneath the condenser. Check for bent or damaged fins and simply repair them if necessary. Check all refrigerant pipes and capillaries for vibration and support them if necessary. Carefully inspect all refrigerant pipes for signs of oil leakage, thus determining the leakage position.

### 3) Compressor

The compressor fault is generally classified into two types:

Motor fault (such as winding burnout, insulation failure, short-circuit between coils and so on).

Mechanical fault (such as compressing failure, relief valve fault, Therm-o-disc fault and so on).

If the operating pressure is not established, it indicates that the compressor has failed. It can be confirmed if the suction pressure and discharge pressure are balanced and the motor does not rotate reversely.

The controller has powerful alarm and protection functions to ensure safe operation of the compressor. The maintenance personnel should record the

high pressure and low pressure and find out the cause of an alarm protection during periodical maintenance and inspection.

### 5.3 UPS Power Distribution System Maintenance

Checking UPS status:

Clean the UPS periodically, especially the ventilation holes, to ensure free airflow inside the UPS. If necessary, clean the UPS with a vacuum cleaner. Confirm that the ventilation holes are unobstructed. It is recommended to check the UPS operation status once every half a year.

Check the following items:

- 1) Check whether the UPS is faulty: Is the FAULT indicator on? Is the UPS giving any alarm?
- 2) Check whether the UPS is operating in Bypass mode. Normally, the UPS operates in Normal mode; if it operates in Bypass mode, find out the reason, such as operator intervention, overload, internal fault, and so on.
- 3) Check whether the battery is discharging: When mains is normal, the battery should not discharge; if the UPS operates in Battery mode, find out the reason, such as mains failure, battery test, operator intervention, and so on.

#### Note:

Refer to PL2 RM series UPS User Manual for the detailed maintenance operation and replacing instructions

### 5.4 Troubleshooting

Judge possible causes for the fault through the run data and alarm information in the MSC-C monitoring system, and take measures against the faults, see Table 5-1.

Table 5-1

Fault phenomenon	Possible cause	Check or remedy
Environmental high-temperature alarm	Unreasonable High-temperature setpoint	Check the high-temperature alarm point
	Use in overload	View whether the max. actual heating load is over the rated value

	Fan is faulty	Contact Everexceed
	The AC refrigeration output is faulty	Contact Everexceed
	The closed doors are not closed completely	Check all closed doors and close them
Door sensor alarm	The closed doors are not closed completely	Check all closed doors and close them
	The door sensor is not installed well or damaged	Readjust the installation clearance
Water leakage detective belt sensor alarm	There is water in the detection belt area	Check the leaking place in the computer room
	AC condensate water leakage	Check that the connection of the condensate water pipes are reliable
PDU over-load alarm	PDU exceeds the load setpoint	Check the actual load power of single PDU
	PDU less than the limit of load setpoint	Check the actual load power of single PDU
UPS bypass fault	UPS overload	Check the load is over the rated value
	UPS inverter fault	Contact Everexceed
	UPS did not press the ON/OFF key	Press UPS ON/OFF switch until the inverter LED on
Communication fault	Communication line connection is not reliable	Check the communication line
AC fan alarm	Fan fault	Contact Everexceed